













Water Solutions and Services Guide

 Saur Industrial Water Solutions Division:

-  njihuis
-  econvert
-  unidro
-  nortech
-  riventa
-  pwnt
-  byosis
-  sodai
-  aqua-chem
-  flootech
-  mobile water solutions

#missionwater

Water Solutions and Services Guide

	(04)
Facts and Figures	
Water Solutions and Services for all industries	(06)
Customer-For-Life and Value-Added Services	(08)
Portfolio)	
Pre-Treatment	(11)
Secondary Treatment	(12)
Tertiary Treatment	(13)
Industrial Water Reuse	(14)
Sludge Management	(15)
Water Refinery and Energy Factory	(16)
Process Water Solutions for Purified / Drinking Water and Pure Steam Needs	(18)
Cooling Water and Cooling Tower Engineering/Optimisation	(19)
Drinking Water and Desalination solutions	(20)
Municipal Wastewater	(21)
Resource Recovery & Waste to Value	(22)
	(23)

Safety first

Safety lesson examples



Safety lesson 01

01

'I don't go down into a trench if it isn't completely safe.'



Safety lesson 02

02

'I always think before I act, even if it means putting an operation on hold.'



Safety lesson 03

03

'I act professionally, sticking to my expertise and calling in other experts whenever necessary.'



Follow us on social networks

www.nijhuissaurindustries.com

Contact :
marketing@nijhuisindustries.com

This portfolio brochure is published by the Marketing-Communication team of Nijhuis Saur Industries in corporation with the companies within the Saur Industrial Water Solutions division.

Design and production:
RaytorMedia and NSI Marketing Team

Photo credits:
Photo library Nijhuis Saur Industries

Illustration credits: Shutterstock



Integrated solutions to solve industrial and municipal water challenges to close the water loop

The Saur Industrial Water Solutions division provides solid and adaptive solutions for sustainable and resilient water use, energy and resource recovery for Light and Heavy Industries, Utilities, and Commercial Buildings around the world.

With Nijhuis Saur Industries being mainly responsible for the division, we deliver an extensive portfolio of innovative technologies, game-changing solutions and added-value services to protect water resources. With our unique Customer for Life approach, we help industries, utilities, and cities to comply with 'reduce, remove, reuse and recover', closing the water loop.

We deliver innovative technologies, engineering and consulting services, mobile water solutions, EPC / DBFOM project execution and O&M site services.

Our portfolio of water solutions is based on the extensive knowledge and experience of Nijhuis, Econvert, Unidro, Nortech, Riventa, PWNT, Byosis, Sodai, Flootech, Aqua-Chem and NSI Mobile Water Solutions.



Our Purpose: #MissionWater | Complying to Reduce, Remove, Reuse and Recover

Our purpose is to be an advocate for water, ensuring that everyone - utilities, industries, citizens, farmers, non-governmental organizations and civil society as a whole - gives water the value it deserves. Beyond our daily business of providing adequate supplies and responsible quality and treatment of water, we are committed to acting and to convincing others, so that together we can invest in saving water, **reducing** life-cycle costs, **removing** pollution, **reusing** water and heat and **recovering** energy and resources.

We engineer new solutions models to preserve one the most precious resources on our planet and contribute to a sustainable and resilient future! We call it Mission Water.

#mission water

Facts and Figures

Saur Industrial Water Solutions Division

 nijhuis  unidro  econvert  nortech  riventa  pwnt

 byosis  sodai  aqua-chem  flootech  mobile water solutions



>1500
Colleagues in the
Industrial Water
Solutions Division



>140
Countries
active



>300
Industrial O&M
contracts

SINCE

>1904
>119 years of
knowledge



>500
Million Order
Entry



>500
Mobile Water /
Rental Solutions +
3 Regeneration facilities



>50.000m²
Manufacturing
surface in Europe and US



>500
New projects
a year



>5000
References

**In a
nutshell,
we:**

**Integrate
Systems**
and act as
EPC or DBFOM
contractor

**Deliver
Technologies
and Solutions**

**Provide
(mobile)
services and
consumables**

**Operate
and
Maintain
(O&M)**

Contact

Saur Industrial Water Solutions Division:

Nijhuis Saur Industries

Doetinchem, the Netherlands

7007 CD - info@nijhuisindustries.com

+31 314 74 90 00

Or contact one of offices and
companies around the world:

www.nijhuissaurindustries.com/contact

Water Solutions and Services for all industries

Light Industries

Pharma and Cosmetics



Industry Expertise: nijhuis aqua-chem

Meat Processing and Agricultural



Industry Expertise: nijhuis aqua-chem byosis econvert

Food, Beverage and Dairy



Industry Expertise: nijhuis aqua-chem byosis econvert flootech

Pulp and Paper



Industry Expertise: flootech econvert nijhuis

Semiconductors and Battery plants



Industry Expertise: nijhuis aqua-chem flootech

Heavy Industries

Renewable Energy and Power Plants



nijhuis sodai unidro flootech econvert

Oil and Gas (Up-Mid-Downstream)



Industry Expertise: nijhuis unidro flootech nortech

(Petro)Chemical



nijhuis sodai unidro flootech

Mining & Minerals



Industry Expertise: nijhuis flootech

Shipbuilding, Marine, Offshore



Industry Expertise: nijhuis aqua-chem unidro

Municipal

Water Intake, Drinking Water and Desalination



Industry Expertise: nijhuis pwnt sodai riventa flootech

Municipal Wastewater



Industry Expertise: nijhuis byosis riventa

Decentralized Solutions

Buildings | Festivals | Urban/Remote Areas



Industry Expertise: nijhuis

Mobile Water Solutions



Industry Expertise: mobile water solutions

Plant Operation & Maintenance



More industries:

Light: Algae, Textile and Tanneries, Plastic Production and Recycling
Heavy: Cement & Brick, Metals.

Industry Expertise: nijhuis

Integration of 'reduce, remove, reuse and recover' philosophy into our design:



- **Reduce** operation cost, carbon footprint, energy, chemicals, sludge, manpower and maximise asset data.
- **Remove** pollution such as micropollutants, resistant bacteria, solids and COD and be compliant to regulatory frame works.
- **Reuse** effluent to process- or drinking water, CIP fluid and turn ground water/surface water/sea water to drinking water.
- **Recover** nitrogen, biofat, biogas, energy, water and caustic (as product).
- Integrated and turn-key **water-on-demand** solutions and services.
- **Design, Build, Finance, Maintain and Operate** for solutions and systems in water and wastewater treatment and gas purification.
- **Consultancy**, process studies, field support & trustworthy operation, monitoring and maintenance services.
- **Mobile water solutions** for a fast-track project execution, operational emergencies and modular expansion of treatment plants.
- **Continuous innovation** to help you reduce life-cycle cost and meet the rising demands of environmental and legal requirements.

Customer-For-Life and Value-Added Services

We design, build, finance, operate and maintain (waste)water treatment plants for a sustainable and resilient future, with a unique portfolio of smart and game-changing solutions in sustainable water use, energy and resource recovery.

Choosing the Saur Industrial Water Solutions division means working together with an innovative and reliable water solutions and services specialist. When partnering to execute specific needs on water treatment, a long-term vision and strategy is necessary.

Through partnering with us, you can keep your cost as low as possible based on the latest local regulations or upcoming changes within the local discharge limits. To be in compliance and lower the environmental footprint can be a difficult task when you are not aware of all specific challenges on water.

The sooner our involvement within your supplier selection process, the better your water treatment installation and operations will meet the best possible business case and provide you peace of mind.

The 'Customer-For-Life' approach consist of the following steps:

- 1. Optimising and consultancy:** treatability analysis, maximise asset data, feasibility study, feed study or detailed design.
- 2. Best available technology:** project execution & commissioning.
- 3. Operation and maintenance:** remote monitoring, process efficiency.
- 4. Innovation and continuous improvement:** reduce, remove, reuse and recover.

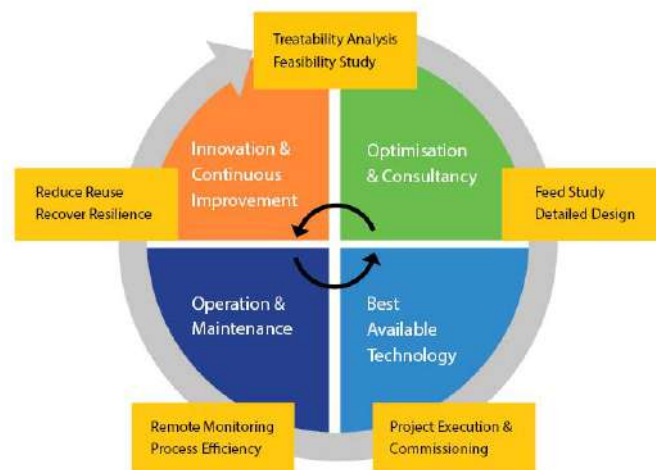

Research & Development

Our experienced Research and Development experts are continuously working on the development of game-changing solutions for purifying (waste)water and recovering valuable resources.

We perform a wide variety of tests executed in our state-of-the-art equipped laboratory facilities, often supported by pilot trials on-site.



Scan the QR code and discover one of our manufacturing facilities



Design & Consultancy | Project Management & Engineering

Our in-house design and consultancy support team has extensive experience undertaking all types of water, wastewater, planning support, flood risk, construction, structural design, pump and blower optimisation and other environmental consultancy work.

Our team of experienced and locally-based Project Managers and the Design Teams are responsible for meeting the objectives of the project in close relationship with our clients and the project team based on a fast-track approach.



Manufacturing | Inspection, Packing and Delivery On Site

We provide the most sophisticated manufacturing workshops in the Netherlands, Italy and US, securing our customers with the highest quality against a competitive price for standardized systems or customized solutions including international standards like ATEX, Norsok, UL and CSA.

Before the equipment leaves the manufacturing facility, the equipment is inspected and tested. The quality inspection records are reviewed by our quality controllers to comply to the required standards and/or your standards.

Installation and commissioning











Installation site works, start-up and commissioning are provided with local support and partners. The civil construction works phase can start during different stages of the project depending on the ground conditions, equipment supply and planning. After start-up, our experts can operate and maintain your plant to comply with the local environmental legislation.

Our Sustainable Water Coaches and i-MONITORING operation and maintenance team can support your system or plant to maximise the performance and provide you peace of mind.



Water Solutions and Services portfolio overview

Saur Industrial Water Solutions Division:

 nijhuis  econvert  unidro  nortech  riventa  pwnt
 byosis  sodai  aqua-chem  flootech  mobile water solutions

#missionwater

Pre-Treatment Solutions

Reduce discharge cost | Reduce OPEX cost | Reduce Chemicals |
Remove particles | Your first step to Reuse Water

Separate large particles: Filters / Screening

Filter systems are used as primary screening to separate large particles from your wastewater. Removal of these particles prevents downstream pipe blockages and protects upstream equipment.

- **NPS:** Self-cleaning channel filter Aquarake
- **NZB:** Curved screen to remove coarse particles
- **NTF:** Inside fed rotary drum screen for screening large coarse, fine filters and/or thickening application
- **NDF:** Inside fed cloth drum filter
- **Cartridge filter:** Different types / poresize cartridge filter, single or multiple skid-mounted systems

Effective solids removal: Flotation (i-DAF)

The Dissolved Air Flotation system is based on proprietary and intelligent aeration system (i-AERATION) which forms fine air bubbles that support and increase the separation of particles. The DAF units can be supplied with several add-ons, making the unit the most intelligent DAF (i-DAF) on the planet.

- **IPF & NPF:** Compact flotation unit with plate packs
- **GDF:** Next generation of modular open flotation units without plate packs for handling high solids loadings
- **High Rate i-DAF:** DAF systems for large capacities above 800 m³/hr / 20 MLD, executed in stainless steel (304, 316, duplex or super duplex) or concrete, with or without plate pack
- **DGF/DNF:** Dissolved Gas Flotation using for example nitrogen-gas or biogas in the aeration system
- **ICF(F):** A revolutionary next generation system DAF based on a plug and play principle, available in boxframe or containerised set-up
- **Floodaf®:** DAF unit as single-level low construction and highly efficient dispersion water system with a small footprint especially suitable for the pulp and paper market



Gravity Separators

Remove heavy settling and floating particles from water without the addition of chemicals and energy.

- **NTB:** Robust and straightforward sedimentation unit / lamella settler
- **NSS:** Sand separator to remove sand and sediment
- **API:** Gravity separation device designed by using Stokes Law
- **CPI:** Oil water separator in a concrete basin
- **CCS:** Oil water separator in a stainless steel unit
- **PPA module:** Standardized plate pack module, integrated in CPI's

Coagulation & Flocculation

Remove emulsions, dispersions and heavy metals from the wastewater by adding coagulant, flocculant or precipitant.

- **i-NEC:** Electrocoagulation by an electrical process without the dosage of chemicals applicable to industrial, municipal, bioenergy and mining wastewater
- **PFR:** Pipe flocculator, designed for effective mixing of chemicals with wastewater
- **Mixing tanks:** concrete or pp tank with mixer, designed for effective mixing of chemicals with wastewater
- **CDU/FDU:** Skid mounted chemical dosing units
- **NMA / NMM:** Flocculant make up units
- **i-FLOC:** Intelligent flocculants which are economical to use
- **ILCA®:** In-Line Coagulation and Adsorption for surface waters for the CeraMac® system

Online Measuring and Control Solutions

- **Intelligent Dosing (i-DOSE):** The i-DOSE system ensures operational excellence with real-time control based on the actual pollution load for pre-treatment, secondary treatment and tertiary treatment
- **Effluent Quality (i-QUALITY):** The i-QUALITY system gives realtime insight into the effluent quality and provides an overview of operational trends



Secondary (An)Aerobic Biological Treatment

Reduce discharge cost | Reduce OPEX cost | Remove COD & BOD |
Recover Energy/Biogas | Recover Nitrogen

Based on a biological process, controlled under aerobic conditions (with aeration) that effectively treats COD, BOD and VSS into water, carbon dioxide and new biomass.

Aerobic Treatment (Bioctor)

- Bioctor-SBR: Compact and flexible to operate single tank solution
- Bioctor-CONTINUOUS/FLOT: Water flows by gravity through the required steps of treatment of a continuous system, with a clarifier or (High Rate) i-DAF for sludge and water separation
- Bioctor-MBR: A sludge water separation system by membranes, using flat plate or hollow fibre membrane modules
- Bioctor-FlooBed®: A compact system with the addition of biocarriers (patented technology), resulting in more effective growth of bacteria
- Bioctor-HRNR: Removal of nitrogen from highly concentrated side-streams with HRNR technology
- NEREDA®: Award-winning technology with aerobic granular biomass for industrial wastewater applications

Aeration systems (Flex-Aeration)

We offer a wide range of surface and bottom aeration solutions, resulting in flexible and custom-made configurations, providing a complete aeration package and installed into a new situation or retrofit.

- NFA-S: High or low speed aerators
- NFA-B: Tubes or disc diffusers membranes

Anaerobic Treatment (Econvert)

Based on a biological process, controlled under anaerobic conditions that effectively treats COD, BOD and VSS while producing biogas, heat and very little biomass (without oxygen).

- Econvert-EGSB/UASB/IR®: High-rate anaerobic technology offers high COD and BOD wastewater removals in a highly loaded anaerobic system with minimized footprint
- Econvert-DGF®: A revolutionary and highly innovative solution, treating wastewater with high TSS and/or FOG. The concept provides a single step process solution

- Aecomix™-TAURUS: The reactor is suitable for all types of waste, sludge and renewable energy crop based on a mixed and heated digester tank

Biogas Treatment & Utilisation (Econvert)

Biogas can be used to feed boilers, gas engines or Combined Heat & Power (CHP) installations or can be upgraded to green or natural gas and supplied to the electricity grid. Econvert offers a full range of biogas gas treatment and utilisation solutions such as biogas buffers, biogas flares, biogas blowers/compressors and biogas cooling/drying.

- Econvert-Dsulph®: the perfect blend of biology and chemistry. Biogas typically contains H₂S, a component harmful to you and your equipment. This desulphurization unit combines the chemical absorption of H₂S in the scrubber with the biological recovery of elemental sulphur in the bioreactor.

Digestate Treatment

In order to treat the digestate/effluent after the Aecomix™-TAURUS process to discharge or reuse requirements, we offer a wide range of polishing, reusing and recovery solutions.

- ByoFlex® / ByoNix®: with the revolutionary ByoFlex® or ByoNix® system nitrogen is recovered from highly contaminated substrates and used as fertilizer. The system is a one-of-a-kind ammonia stripping unit.



Tertiary Treatment

Reduce discharge cost | Removal of micropollutants, medical residues and TSS | Reduce OPEX cost | Reuse water for irrigation

Tertiary DAF (Tertiary i-DAF & FlooDaf®)

Remove phosphorous and suspended solids from a tertiary wastewater stream.

CarboPure (CP)

Combines conventional activated carbon filtration with air dissolving technology to achieve low COD requirements.

CarboPlus

Proprietary and compact solution wherein water and carbon separate by gravity. New carbon is automatically injected and a fluidized bed filled with micro granular activated carbon removes efficiently micropollutants.

PACAS

Powdered Activated Carbon in Activated Sludge (PACAS) for the removal of micropollutants.

1-Step Polishing (1-STEP® Filter)

Innovative filter combining four processes in one single unit to remove i.e. nutrients, heavy metals and micro pollutants.

High Rate Intelligent Continuous Sand Filter (High Rate i-CSF)

The compact unit design is based on a high-rate hydraulic capacity on a small surface. The HR i-CSF polishing sand filtration removes TSS, P and $\text{NO}_3^- / \text{NH}_4^+$ in order to protect water resources and address water scarcity. Optionally it can be extended with the Sand-Cycle, a smart monitoring tool to optimise performance.

Pressurized Sand Filter (ContiSand)

For especially heavy industries, the ContiSand is a continuously operating sand filter with no need to stop the operation for backwashing or cleaning. They only need pressurized air or gas, either PA provided by utility system or generated by a dedicated small compressor.

Gravity Sand Filter (FlooSand™ G)

Robust stainless steel under strain system for open top gravity filtration tanks with simultaneous air and water backwash feature. The technology is especially competitive for high filtration capacities over 100 m³/h per filter cell.

Micropollutants Removal (MicroOxi)

Post treatment solution to remove micropollutants which consists of a smart combination of oxidation technologies.

Medical Residues Removal (MediOxi)

A cost-effective decentralized pre-treatment solution removing 80-99% of medicines, radiocontrast agents and resistant bacteria from healthcare and hospital wastewater.

UV Disinfection (NUV)

Disinfection can be achieved by UV-C radiation, a specific light wavelength that damages the DNA structure of micro-organisms.

Nutshell filter

Nutshell Filters are the result of our experience in media filtration as well as our know-how in dealing with produced water and are successfully performing in different conditions and situations.

Pre-coat filter

The precoat filter consist of a vertical cylindrical vessel with conical bottom, with filtering candles fixed at their top on horizontal nozzle sheet or collecting manifolds.



Industrial Water Reuse

Reduce discharge cost | Reuse water for production | Removal of brine | Reduce OPEX with energy efficient membrane solutions

- **Ultra Filtration (UF) membranes**

The skid-mounted UF technology offers a superior barrier for viruses and bacteria removal and a solid pre-treatment for reverse osmosis. The small pore size ensures reduced membrane fouling. Our DEEPEST technology containing titanium membranes (TiO₂ membranes) consists of an internal titanium liner combining unique properties with top-level performance for difficult to treat wastewater.

- **Direct Nano Filtration (dNF) membranes**

With the dNF, minimum pre-treatment is required. This unit can be implemented to remove color, bacteria and viruses for drinking water and wastewater applications in one single step: without pre-treatment and without the use of chemicals.

- **Reverse Osmosis (RO) membranes**

The reverse osmosis technology has maximal efficiency due to a smart design and high quality execution of the skid. The unit removes dissolved components, such as ions, heavy metals, TOC and viruses.

- **Ceramic membrane (CeraMac®)**

CeraMac® is an innovative and cost-effective ceramic membrane filtration process to produce drinking water. This design allows the economically feasible use of ceramic membranes on surface water for large-scale applications, as well as in reuse and desalination pre-treatment applications.

- **Electro-deionization (EDI)**

Electro-deionization is a continuous process used to polish deionized water, a chemicals-free alternative to conventional resin mixed bed exchangers. It is a form of deionization that uses electricity to remove the ions from the water.

- **Suspended ion exchange process (SIX®)**

SIX® is a suspended ion exchange process as an alternative to coagulation for organics removal. It is suitable for treating surface waters to remove dissolved organics.

Brine Treatment Solutions (MLD / ZLD)

- **Evaporator (No-Briner)**

Modular innovative plastic multi-effect evaporator with exchangeable cartridges.

- **Concentrator**

Evaporator for brine of RO concentrates.



Sludge Management

Reduce sludge discharge cost | Recover fertilizer | Reuse water

• Drum Filter (NDF):

The cloth drum filter is an inside fed screen with a perforated drum covered by a cloth, specially designed for dewatering excess sludge up to 6% dry solids or as solid and liquid separation for manure.

• Screw Press (NSP):

A sludge screw press is a flexible sludge solution, separating sludge into a liquid and a solid fraction.

• Screw Conveyor (NSC):

A screw conveyor is a mechanism that uses a rotating helical screw blade to transport thickened sludge.

• Decanter Centrifuge:

A decanter centrifuge separates solids from one, two or three liquid phases in one single continuous process.

• Screw Screen Compactor (NSSC):

A screen compactor washes and lifts screenings to a convenient height for disposal.

• Sand Screw (NSS):

A sand screw separator removes fast settling solids, such as sand.

• Chamber Filter Press (NCFP):

Filter presses dewater sludge in chambers by applying very high pressures to the system.

• Belt Press:

Dewatering of sludge by a belt system, first stage by gravity, followed by a pressurized belt for further dewatering.

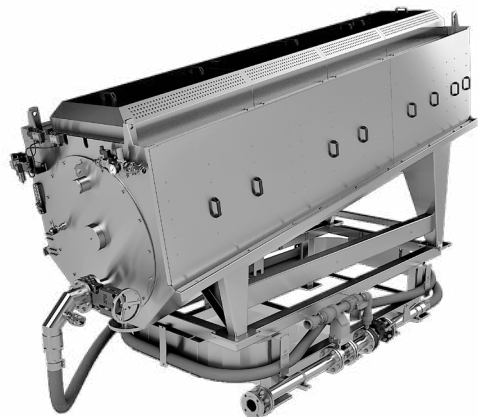

Water Refinery and Energy Factory

A closed loop solution for light industries

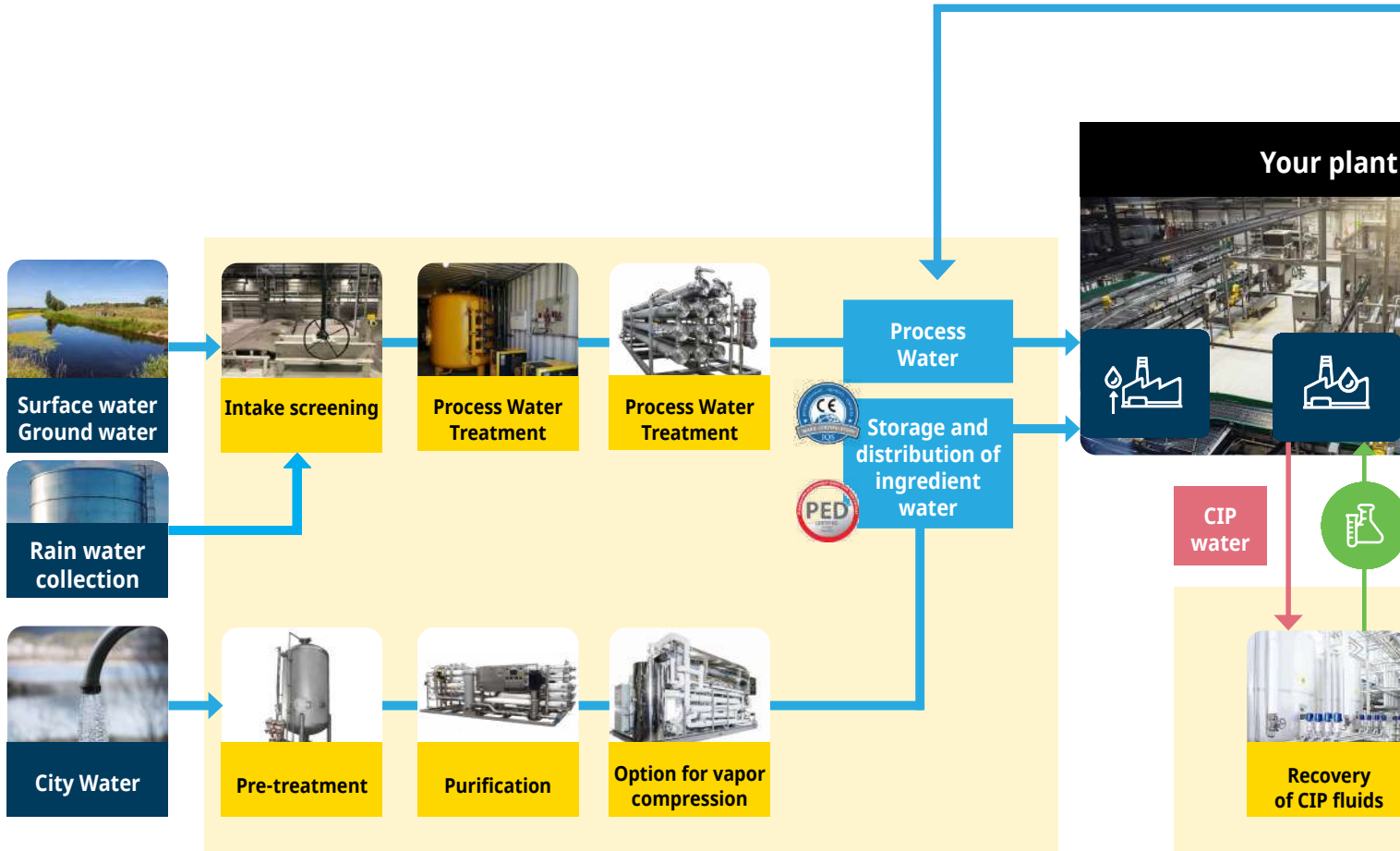



Digital Solutions
 SMART diagnostics & control

Mobile Water Solutions
 Emergencies / fast track execution

DBFMO / EPC contractor
 / solution provider

Reduce cost, energy and water consumption with a closed loop concept

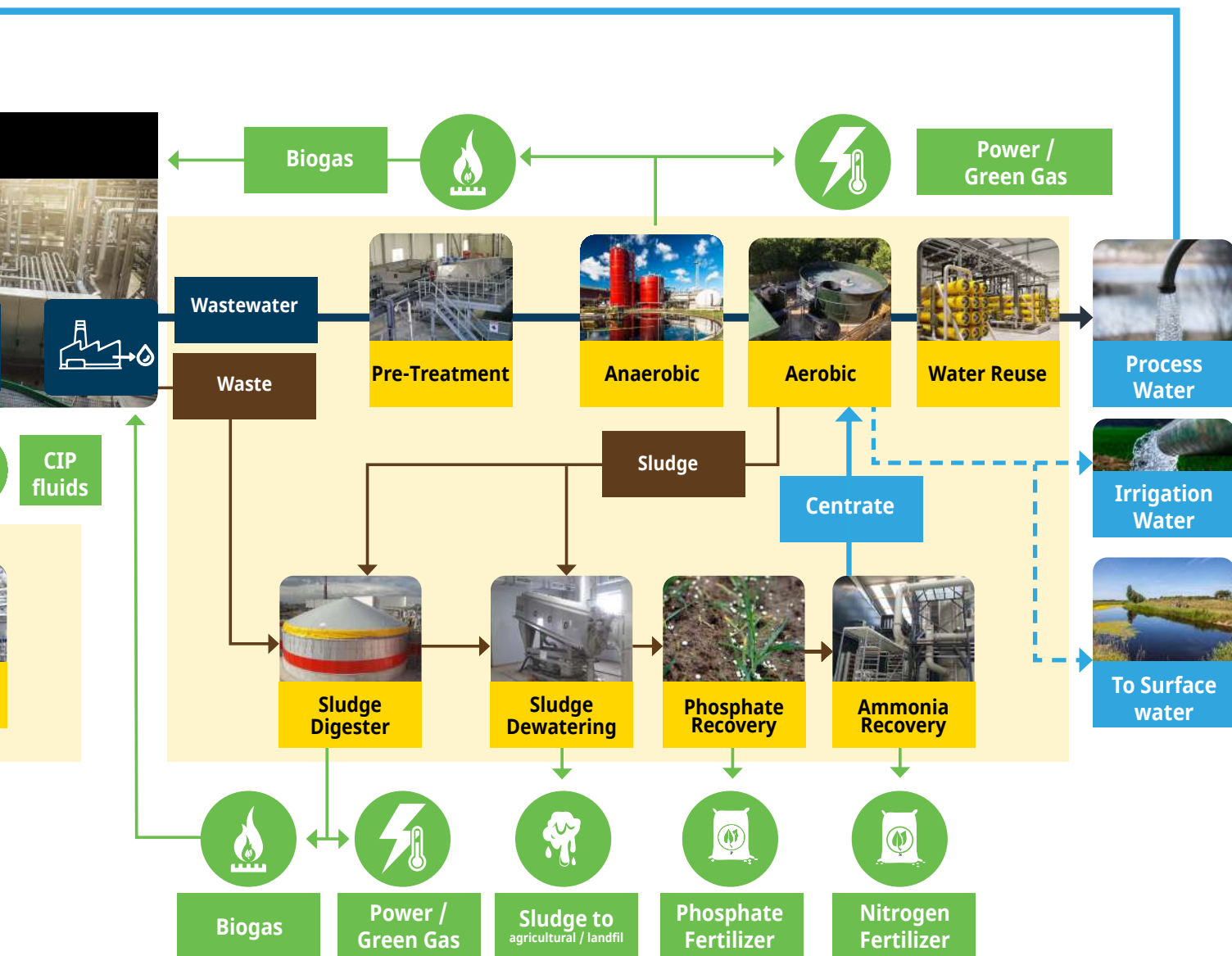
Environmental compliance | closed loop to reduce water intake | guarantee of water and energy, avoid production stops | improving performance | improving efficiency | capacity increase | improving water quality | recover power / green gas | reuse process water | reduce sludge | minimize local water scarcity risk



#mission water

Process Water Solutions for Purified / Drinking Water and Pure Steam

Remove contaminants | High Purity Water & Pure Steam Solutions

• Vapor Compression Distillation:

We deliver a variety of standard models of Vapor Compression Distillers. The innovative design delivers reduced energy consumption and has less stringent feedwater requirements when compared to other distillation processes like multiple-effect systems, making our Vapor Compression Distillers a popular and sustainable choice for water purification.

All components are accessible from floor-level, with the compressor and pump conveniently located at the edge of the skid for easy serviceability. We utilize low-speed compressor technology, which results in cooler bearing temperatures and less downtime.

• Reverse Osmosis

Our range of Reverse Osmosis (RO) Systems are the result of decades of experience engineering the most efficient and sustainable systems to produce purified ingredient water for the beverage industry, pure water solutions for oil & gas and the military. Our Reverse Osmosis Systems are highly customizable utilizing a wide range of membranes from a variety of suppliers.

This flexibility means that we can balance all aspects of the purification process at your facility; feed water conditions, permeate quality requirements, energy consumption, and recovery goals to create the most efficient and sustainable system for your facility.

• Pure Steam

Our Pure Steam Generator design provides consistent high quality pure steam for the Pharmaceutical, Biotechnology, Hospital, Laboratory and other industries. All internal and external aesthetics have been designed to meet the stringent

demands of sterile environments. Equipment reliability, product quality, and safety are standard features built-in to each unit.

The unique evaporator with double tube sheet design prevents product contamination to the pure steam.

• Tactical Water Purification System

Increased capacity, reduced footprint water purification system designed to produce potable water from a broad range of water sources.

Our Tactical Water Purification System (TWPS) provides a rapidly deployable water purification system capable of producing up to 5 m³ (1,500 GPH) of potable water from a feedwater source and 5 m³ (1,200 GPH) from a seawater source.



Beverage Water Room



Vapor Compression Distillation



TWPS



Reverse Osmosis Membrane Based WFI / PW Systems

Cooling Water and Cooling Tower Engineering/Optimisation

Reuse of cooling water | Avoid legionella and biofouling

• Complete Cooling Tower Solutions

This includes mechanical inspection surveys to benchmark performance and plan maintenance activities. All works are carried out by trained technicians to improve cooling performance and maintain the cooling tower to ensure compliance with local Legionella regulations.

• Spare Parts and Preventive Maintenance

All cooling towers can be supplied with spare parts and are part of a total service package including water treatment and compliance documentation.

• Water Recycling of Process Streams

Cooling tower make up and reuse of blowdown provides excellent opportunities for costs savings and improved environmental performance. This is possible through the use of patented bio organic catalysts, membrane technology.



Legionella & Biofouling

Ozone Solutions

Chemical free solution to eliminate biofilm and bacteria, remove pharmaceuticals and color, and treat cooling water and pasteurisation/ sterilization lines.

Electrocoagulation (i-NEC EOX)

Electrocoagulation solution combined with oxidation technologies (EOX technology) to remove specific chemical compounds for process water streams in one single step.

Automatic Tube Cleaning (ATC)

Provides a permanent solution to combat scaling and fouling problems for heat exchangers for a wide range of industries.



Drinking Water and Desalination solutions

Recover drinking water | Remove particles | Reduce OPEX with cost efficient solutions | Reduce Energy cost | Reduce downtime

• Intake Screening (FlooScreen™):

Proprietary Bar Screen, Travelling Basket Screen and Drum Basket Screen technologies for applications, where high capacities > 1m³/s of high-quality water screening is needed.

• High Rate i-DAF:

Our High Rate i-DAF is a solid solution that guarantees maximum and efficient solids removal, taking primary, secondary and tertiary solids-removal technology to the next level. Especially for the purification of sea and surface water above 800 m³/h / 20 MLD, pre-treatment solutions have to be compact, robust, stable and modular at the same time.

• Suspended Ion Exchange for organics removal (SIX®):

SIX® is a suspended ion exchange process, an alternative to coagulation for organics removal. It is suitable for treating surface waters to remove dissolved organics. The system uses an efficient resin contacting, separation and regeneration system, with brine used up to five times which helps reduce waste streams.

• In-Line Coagulation and Adsorption (ILCA®):

The In-Line Coagulation and Adsorption (ILCA®) process was developed to minimize coagulation/flocculation footprint and to simplify pre-treatment upstream of CeraMac®. For most surface waters, coagulated feed water lowers the ceramic membrane fouling rate, but strong, large, setting flocs are not required for filtration with ceramic microfiltration. ILCA® was developed to provide only the necessary mixing at a short contact time for the CeraMac® system.

• Ceramic membrane (CeraMac®):

CeraMac® is an innovative and cost-effective ceramic membrane filtration process. This design allows the economically feasible use of ceramic membranes on surface water for large-scale applications, as well as in reuse and desalination pre-treatment applications.

• Gravity Sand Filter (FlooSand™ G):

Robust stainless steel under strain system for open top gravity filtration tanks with simultaneous air and water backwash feature. The technology is especially competitive for high filtration capacities over 100m³/h per filter cell.

• Direct nanofiltration membrane (NMS-dNF):

For borehole applications, the membrane solution combines, particle removal, color removal, softening, and partial desalination. Additionally, the solution avoids the installation of a sand filter as pre-treatment and turns borehole water into drinking water in a single step.

• **Reverse Osmosis:** We offer the best technological reverse osmosis solutions for desalination plants. With over 30-year global experience we have designed and built Reverse Osmosis desalination plants both for sea and salty water. Among them the Mossi&Ghisolfi plant in Texas for the production of potable and industrial water used for the production of PTA and PET. The plant, built with advanced technology treats 40.000 m³/day.

• **Network and pump optimisation:** We help to reduce cost, achieve significant reductions in energy and emissions, and boost performance for desalination and drinking water plants via our smart pump optimisation services. We also identify network investments to meet strategic targets and drive greater profit. For example our expertise would deliver real-time pump performance measurement to improve the accuracy of mass balances and lead to improved recognition of media wear.



Municipal Wastewater

Remove medical residues and micropollutants | Reuse water |
Recover Fertiliser | Reduce water scarcity | Reduce odor

Decentralized solutions for municipal wastewater:

Circular Urban Water Solutions – Closed Loop for (Commercial) Buildings, Festivals, Remote locations

Circular Urban Water Solutions apply to remote locations, disaster areas, festivals and villages & buildings. It includes modular building blocks such as grey, black and urine water treatment with more than 50% water savings. The completely self-sufficient solution turns (waste)water (rain, grey, black and yellow water) into the basic elements for life (food & drinks), contributing towards a circular economy.

Solutions for public urination

The GreenPee solution is solving the issue of public urination within urban areas. To bridge the gap between a functional and visually attractive solution, our partner Urban Senses designed the GreenPee, a combination of a urinal and planter. The urinal planter is upgraded into a small circular economy in which the wastewater is treated into valuable resources.

Medical residues removal (MediOxi)

Hospitals, pharmaceutical producers and municipal water authorities need to work together as one, as current wastewater treatment plants are not designed to remove all pharmaceuticals from wastewater. Without action, the remains of pharmaceuticals will enter the sewer through our excrements, and thereafter enter the water chain. To combat these challenges, we have developed together with Van Remmen UV Technology the MediOxi solution, to remove pharmaceuticals from wastewater at hospitals and sewage treatment plants. MediOxi is an innovative treatment method which is modular, flexible, and easy to apply at hospitals and wastewater treatment plants. It consist of Ozone+UV Technology (also known as AOP: Advanced Oxidation Process).

Centralized solutions for municipal wastewater:

- **i-DAF:**

The Dissolved Air Flotation system is based on our proprietary and intelligent aeration system (i-AERATION) which forms fine air bubbles that support and increase the separation of particles. The DAF units can be supplied with several add-ons, making the unit the most intelligent DAF (i-DAF) on the planet.

- **Nutrient, Solids, Micropollutants and Medical residues removal solutions:**

Tertiary DAF (Tertiary i-DAF), High Rate Intelligent Continuous Sand Filter (High Rate i-CSF), CarboPure (CP), CarboPlus, PACAS, 1-Step Polishing (1-STEP® Filter), MicroOxi, NUV, FlooBed®, FlooDaf®.

- **Nitrogen removal and recovery from sludge digesters:**

With the revolutionary ByoFlex® system nitrogen is recovered from highly contaminated substrates. The ByoFlex® system is a one-of-a-kind ammonia stripping unit. Through years of experience, the (ammoniacal) nitrogen stripper has been developed for highly concentrated difficult substrates such as digestate or heavily polluted wastewater. Compared to traditional ammonia strippers the system is robust and has a patented, unique design that ensures there hardly is any clogging of the internal parts.

- **Network and pump optimisation:**

We help to reduce cost, achieve significant reductions in energy and emissions, and boost performance for desalination and drinking water plants via our smart pump optimisation services. We also identify network investments to meet strategic targets and drive greater profit. For example our expertise would deliver real-time pump performance measurement to improve the accuracy of mass balances and lead to improved recognition of media wear.



Resource Recovery & Waste to Value

Recover CIP fluids | Recover Fat | Recover Energy | Recover Fibers |
Recover Oil | Recover Metals | Recover Nitrogen | Reuse Water

CIP recovery from process water (Aeco-CIP):

The Aeco-CIP recovery unit is a plug & play packaged system to treat spent CIP solutions (i.e. hot soda based). We offer modular expanded packaged plants with capacities between 0,5 to 10 m³/hr.

Fat recovery from wastewater into biofuel (Aeco-Fat):

The Aeco-Fat solutions recover fat from industrial wastewater as biofuel and saves chemicals at the same time. It is a total sludge management solution including a dissolved air flotation unit, followed by a unique heating system (disconnecter) and separation into a liquid fat, a water and a solids fraction. This way an economical value has been added to the recovered product.

Modular Manure/Digestate Treatment Building Blocks

We integrate green mineral mining solutions to turn raw manure or digestate into clean water, energy and organic fertilizers based on state-of-the-art technologies. For example, our Genius concept is based on producing green minerals based on an innovative, cost saving and sustainable way and consisting of a combination of smart technologies to produce water.

Modular Manure/Digestate Treatment Blocks

- **Solid/liquid separation:** A decanter centrifuge separates solids from one, two or three liquid phases in one single continuous process.
- **i-DAF:** The Dissolved Air Flotation system is based on proprietary and intelligent aeration system (i-AERATION) which forms fine air bubbles that support and increase the separation of particles. The DAF units can be supplied with several add-ons, making the unit the most intelligent DAF (i-DAF) on the planet.
- **Membrane solutions:** Membrane filtration process in manure treatment is well known for being the least complex and highly energy efficient. Based on our experience and knowledge, we select the best possible technology being part of the modular manure building blocks.
- **Nitrogen Recovery (ByoFlex®/ByoNix®):** With the revolutionary ByoFlex® or ByoNix® system nitrogen is recovered from highly contaminated substrates. The system is a one-of-a-kind ammonia stripping unit.
- **Pasteurization (ByoPast):** With the ByoPast technology, manure, digestate or other substrates can be pasteurized according to the EG standards 1069/2009 or BS-PAS-110. Pasteurization can be a necessary step in order to be allowed to spread digestate on the fields.



Services and Mobile Water Solutions

Reduce OPEX | Reduce installation time | Reduce the life-cycle cost of your water and production plant | Minimize downtime

Consultancy (i-CONSULT):

We provide our consultancy, environmental and scientific services from all around the globe, based on the added value services. We design and engineer the best solution for (waste) water, cooling water, flood water and infrastructure which nowadays can be presented in a virtual reality environment. We offer site audits, (legionella) risk assessments and onsite or laboratory tests (jar tests, biomethane potential tests, biological degradation tests and membrane selection tests).

Pump, processing and production plant optimisation

We deliver optimisation know-how across pumps, processes and plants within water distribution, wastewater collection and heavy industry. Our solutions and technology have been designed to work across an array of applications, unlocking the full potential of pumping systems and ultimately reducing life-cycle costs.

Operation & Maintenance (i-MAINTENANCE):

Keep your system at maximum performance against the lowest total cost of ownership with preventive, corrective and mechanical maintenance programs and spare parts.

Monitoring (i-MONITORING):

Reduce the life-cycle cost of your plant, extend the lifetime and improve the uptime through 24/7 monitoring.

Training / Sustainable Water Coach (i-ACADEMY):

An experienced sustainable water management coach exchanges best practices from around the world and share valuable process information.

Decentralised Control (i-CONTROL):

Minimize your electrical and installation cost with a cost-effective decentralised control method and reduce the installation time.

Mobile Water Solutions

NSI Mobile Water Solutions offers a reliable and secure source of temporary treated water 24/7, 365 days per year, to maintain the continuity of supply to your core operations and minimize downtime. Our proven track record for rapid response and delivering service excellence is unrivalled and enables our customers to preserve production operations when most needed. We apply the latest technologies to your context to meet your requirements. Our wide range of water treatment technologies is available as pre-packaged solutions on a trailer, skid or container for maximum mobility and rapid response.



0 m³/h

0.03 m³/h

66.24 m³/h

67.97 m³/h

Join the #MissionWater movement

Our Purpose: #MissionWater

Complying to Reduce, Remove, Reuse and Recover

Our purpose is to be an advocate for water, ensuring that everyone - utilities, industries, citizens, farmers, non-governmental organizations and civil society as a whole - gives water the value it deserves. Beyond our daily business of providing adequate supplies and responsible quality and treatment of water, we are committed to acting and to convincing others, so that together we can invest in saving water, **reducing** life-cycle costs, **removing** pollution, **reusing** water and heat and **recovering** energy and resources.

We engineer new solutions models to preserve one the most precious resources on our planet and contribute to a sustainable and resilient future!

We call it Mission Water.



 nijhuis  unidro  econvert  nortech  riventa  pwnt

 byosis  sodai  aqua-chem  flootech  mobile water solutions

Saur Industrial Water Solutions Division:

Nijhuis Saur Industries

Doetinchem, the Netherlands
7007 CD - info@nijhuisindustries.com
+31 314 74 90 00

Or contact one of offices and companies around the world:
www.nijhuissaurindustries.com/contact

